

AN1101SSM

CMOS single power supply

Overview

AN1101SSM is an operational amplifier with a single power supply by CMOS diffusion process.

It has low current-consumption compared to general purpose operational amplifier by bipolar diffusion process. 0 V to V_{DD} is available for both input voltage and output voltage. And this IC is widely applicable to the battery-driven equipment and to many amplifier circuits which adopt small package products.

Features

- Low current-consumption: $I_{DD} = 55 \mu\text{A}$ (typ.), $V_{DD} = 3 \text{ V}$
- Operating input/output voltage range: 0 V to V_{DD}
- Small offset voltage: 0.5 mV (typ.)
- Small input bias current: 1 pA (typ.)
- Operating supply voltage range:
2.5 V to 5.5 V or $\pm 1.25 \text{ V}$ to $\pm 2.75 \text{ V}$

Applications

- Various small-size general consumer electronics equipment

Block Diagram

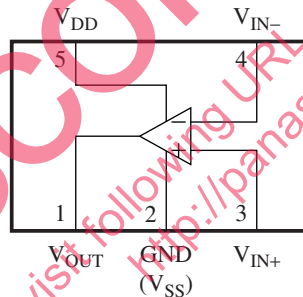

Pin Descriptions

Pin No.	Symbol	Description
1	V_{OUT}	Output
2	GND (V_{SS})	Ground, V_{SS} (negative supply) at using two power supply
3	V_{IN+}	Input (positive)
4	V_{IN-}	Input (negative)
5	V_{DD}	Power supply

Note) The AN1101SSM has been designed for general consumer electronics equipment, not for the specific one requiring such a high reliability that may prevent it from threatening the human lives.

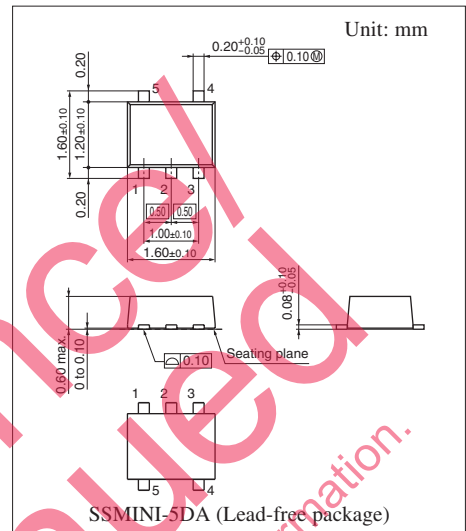

■ Absolute Maximum Ratings

Parameter	Symbol	Rating	Unit
Supply voltage	V_{DD}	5.6	V
Differential input voltage	DV_{IN}	± 5.6	V
Input voltage	V_{IN}	V_{SS} to V_{DD}	V
Supply current	I_{DD}	—	mA
Power dissipation *2	P_D	50	mW
Operating ambient temperature *1	T_{opr}	-30 to +85	°C
Storage temperature *1	T_{stg}	-55 to +125	°C

Note) 1. *1: Except for the operating ambient temperature and storage temperature, all ratings are for $T_a = 25^\circ\text{C}$.

*2: The value at $T_a = +85^\circ\text{C}$.

2. This IC is not suitable for car electrical equipment.

■ Recommended Operating Range

Parameter	Symbol	Range	Unit
Supply voltage	V_{DD}	2.5 to 5.5 ± 1.25 to ± 2.75	V

■ Electrical Characteristics at $V_{DD} = 3.0\text{ V}$, $V_{SS} = \text{GND}$, $T_a = 25^\circ\text{C} \pm 2^\circ\text{C}$

Parameter	Symbol	Conditions	Min	Typ	Max	Unit
Input offset voltage	V_{IO}	Buffer circuit	—	0.5	5.5	mV
Common-mode input voltage	CMV_{IN}	$R_S = 10\text{ k}\Omega$, $R_F = 10\text{ k}\Omega$	0	—	3	V
Open-loop gain	GV	$f = 100\text{ Hz}$	60	90	—	dB
Maximum output amplitude voltage 1	V_{OH}	$R_L \geq 10\text{ k}\Omega$	2.90	2.98	—	V
Maximum output amplitude voltage 2	V_{OL}	$R_L \geq 10\text{ k}\Omega$	—	0.01	0.05	V
Common-mode input voltage rejection ratio	CMRR	$V_{IN} = 0.0\text{ V}$ to 3.0 V , $R_S = R_F = 10\text{ k}\Omega$	50	65	—	dB
Supply voltage ripple rejection ratio *	SVRR	$V_{DD} = 2.5\text{ V}$ to 5.5 V	55	70	—	dB
Supply current	I_{DD}	No load	—	55	100	μA

Note) * : Except for the supply voltage ripple rejection ratio (SVRR), $V_{DD} = 3\text{ V}$.

• Design reference data

Note) The characteristics listed below are theoretical values based on the IC design and are not guaranteed.

Parameter	Symbol	Conditions	Reference	Unit
Offset current	I_O	—	1	pA
Input bias current	I_{IO}	—	1	pA
Slew rate	SR	$R_L \geq 10\text{ k}\Omega$	0.35	V/ μs
Zero-cross frequency	f_T	$A_V = 1$	0.8	MHz

■ Technical Data

- $P_D - T_a$ curve of SSMINI-5DA

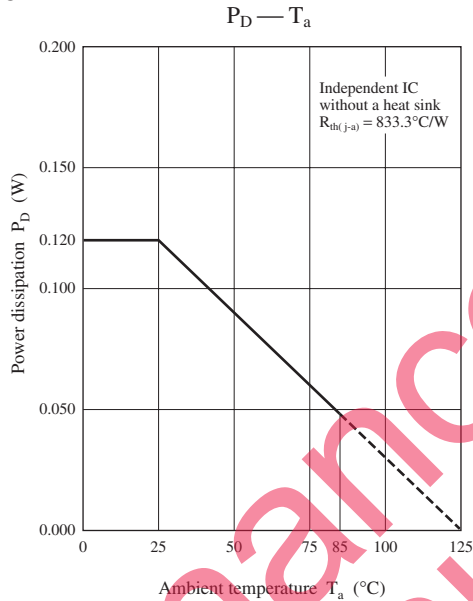

• Main characteristics

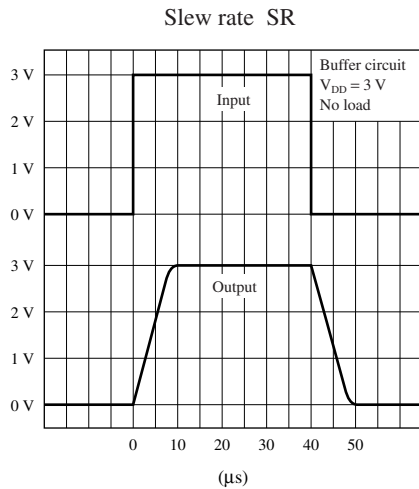
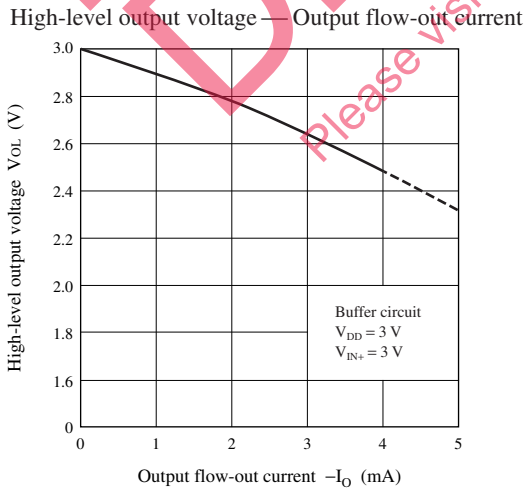
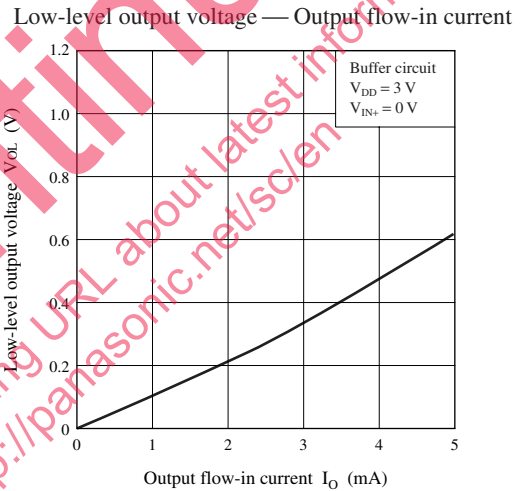
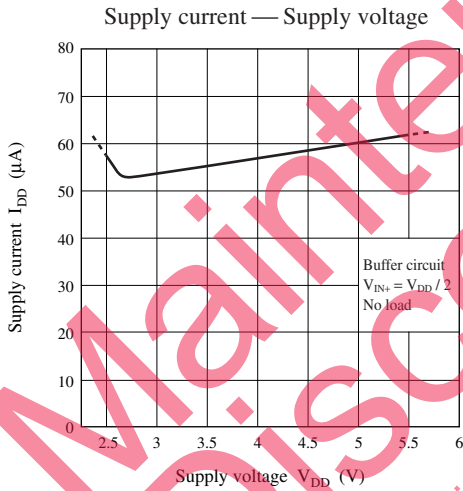

■ Technical Data (continued)

• Main characteristics (continued)

Offset voltage — Ambient temperature

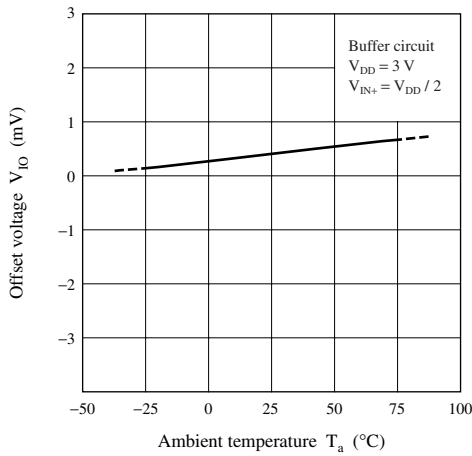

Supply current — Ambient temperature

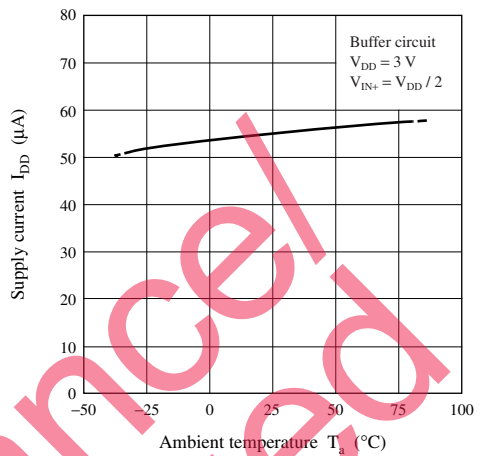

Voltage gain · Phase — Frequency characteristics

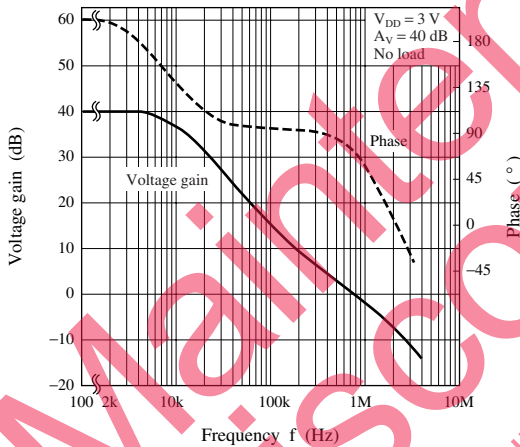

■ Application Circuit Example

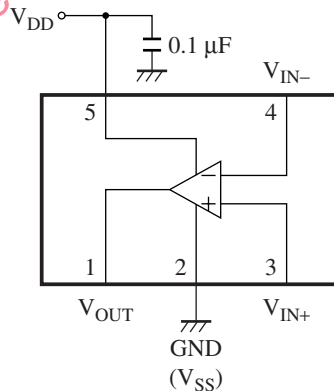

Request for your special attention and precautions in using the technical information and semiconductors described in this book

- (1) If any of the products or technical information described in this book is to be exported or provided to non-residents, the laws and regulations of the exporting country, especially, those with regard to security export control, must be observed.
- (2) The technical information described in this book is intended only to show the main characteristics and application circuit examples of the products, and no license is granted under any intellectual property right or other right owned by our company or any other company. Therefore, no responsibility is assumed by our company as to the infringement upon any such right owned by any other company which may arise as a result of the use of technical information described in this book.
- (3) The products described in this book are intended to be used for standard applications or general electronic equipment (such as office equipment, communications equipment, measuring instruments and household appliances).
Consult our sales staff in advance for information on the following applications:
 - Special applications (such as for airplanes, aerospace, automobiles, traffic control equipment, combustion equipment, life support systems and safety devices) in which exceptional quality and reliability are required, or if the failure or malfunction of the products may directly jeopardize life or harm the human body.
 - Any applications other than the standard applications intended.
- (4) The products and product specifications described in this book are subject to change without notice for modification and/or improvement. At the final stage of your design, purchasing, or use of the products, therefore, ask for the most up-to-date Product Standards in advance to make sure that the latest specifications satisfy your requirements.
- (5) When designing your equipment, comply with the range of absolute maximum rating and the guaranteed operating conditions (operating power supply voltage and operating environment etc.). Especially, please be careful not to exceed the range of absolute maximum rating on the transient state, such as power-on, power-off and mode-switching. Otherwise, we will not be liable for any defect which may arise later in your equipment.
 - Even when the products are used within the guaranteed values, take into the consideration of incidence of break down and failure mode, possible to occur to semiconductor products. Measures on the systems such as redundant design, arresting the spread of fire or preventing glitch are recommended in order to prevent physical injury, fire, social damages, for example, by using the products.
- (6) Comply with the instructions for use in order to prevent breakdown and characteristics change due to external factors (ESD, EOS, thermal stress and mechanical stress) at the time of handling, mounting or at customer's process. When using products for which damp-proof packing is required, satisfy the conditions, such as shelf life and the elapsed time since first opening the packages.
- (7) This book may be not reprinted or reproduced whether wholly or partially, without the prior written permission of Matsushita Electric Industrial Co., Ltd.

Maintenance
Discontinued

Please visit following URL about latest information:
<http://panasonic.net/sc/en>